

# Installation, Maintenance, and Repair Manual

## Series 4000SS, 5000SS

### Reduced Pressure Zone Assemblies Reduced Pressure Detector Assemblies

2½" – 6"

#### ⚠ WARNING



Read this Manual **BEFORE** using this equipment.

Failure to read and follow all safety and use information can result in death, serious personal injury, property damage, or damage to the equipment.



Keep this Manual for future reference.

#### ⚠ WARNING

You are required to consult the local building and plumbing codes prior to installation. If the information in this manual is not consistent with local building or plumbing codes, the local codes should be followed. Inquire with governing authorities for additional local requirements.

#### ⚠ WARNING

**Need for Periodic Inspection/Maintenance:** This product must be tested periodically in compliance with local codes, but at least once per year or more as service conditions warrant. If installed on a fire suppression system, all mechanical checks, such as alarms and backflow preventers, should be flow tested and inspected in accordance with NFPA 13 and/or NFPA 25. All products must be retested once maintenance has been performed. Corrosive water conditions, and/or unauthorized adjustments or repair could render the product ineffective for the service intended. Regular checking and cleaning of the product's internal components helps assure maximum life and proper product function.

#### ⚠ WARNING

The installation and maintenance of backflow assemblies should be performed by a qualified, licensed technician. Failure to do so may result in a malfunctioning assembly.

#### NOTICE

For Australia and New Zealand, line strainers should be installed between the upstream shutoff valve and the inlet of the backflow preventer.

Fittings such as end connectors intended to join alternative pipe systems made from other materials (such as plastics) shall also conform to the relevant dimensional and performance requirements of the appropriate Australian, New Zealand, or joint Australian–New Zealand Standard for the alternative pipe system.

## Testing

For field testing procedure, refer to Ames installation sheets IS-A-ATG-1 at [watts.com](http://watts.com).

For Australia, refer to Australian standard AS/NZS 2845.3.

For other repair kits and service parts, refer to the Backflow Prevention Products Repair Kits & Service Parts price list PL-A-RP-BPD at [watts.com](http://watts.com).

For technical assistance, contact your local Ames representative.

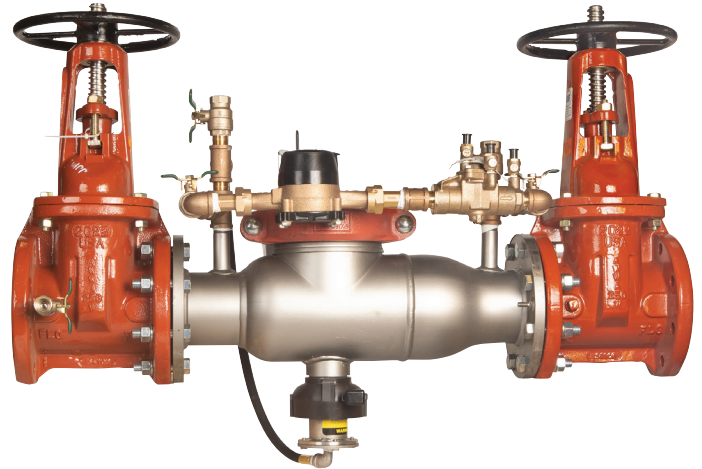

5000SS-OSY with Flood Sensor

Series 4000SS and 5000SS each include a flood sensor that detects excessive relief valve discharges and triggers notification of potential flood events.

#### NOTICE

An add-on connection kit is required to activate the flood sensor. Without the connection kit, the flood sensor is a passive component that does not communicate with any other device. (A retrofit sensor connection kit is also available for existing installations. See "Add-on and Retrofit Sensor Connection Kits," for ordering details.)

#### NOTICE

Use of the flood sensor does not replace the need to comply with all required instructions, codes, and regulations related to installation, operation, and maintenance of this product, including the need to provide proper drainage in the event of a discharge.

Watts® is not responsible for the failure of alerts due to connectivity or power issues.

# Installation Guidelines

## NOTICE

The flange gasket bolts for the gate valves should be retightened during installation as the bolts may have loosened due to storage and shipping.

Assembly body should not be painted.

- Before installing any Ames assembly, flush the line thoroughly to remove all debris, chips, and other foreign objects. Failure to do so may make the assembly inoperable.
- Ames 4000SS and 5000SS Reduced Pressure Zone assemblies are approved by Asse (American Society of Sanitation Engineers) to be installed in horizontal positions. Local water authorities must approve all installation configurations.
- Allow sufficient clearance around the installed assembly to conduct testing, servicing, and inspection. Allow a minimum of 12" from the flood level to the bottom of the assembly.
- The 4000SS and 5000SS assemblies are not recommended for pit installations. Where necessary, an air gap drain may be connected to the relief valve to minimize flooding of the surrounding area. Flooding may cause a cross-connection. Contact local code authorities for proper installations.
- If installing on a fire protection system, purge air from the fire system. Fill the system slowly with all inspectors test valves open.

Indoor Installation

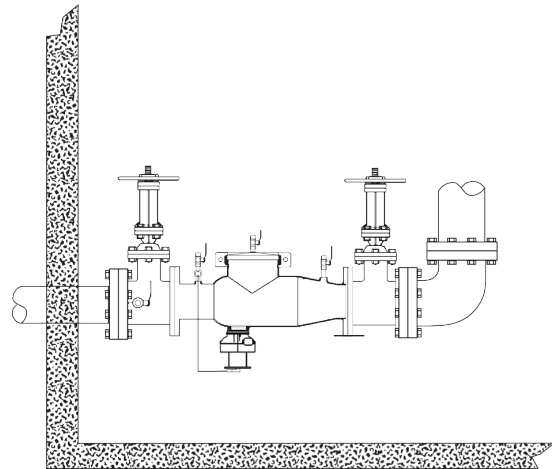

Outdoor Installation

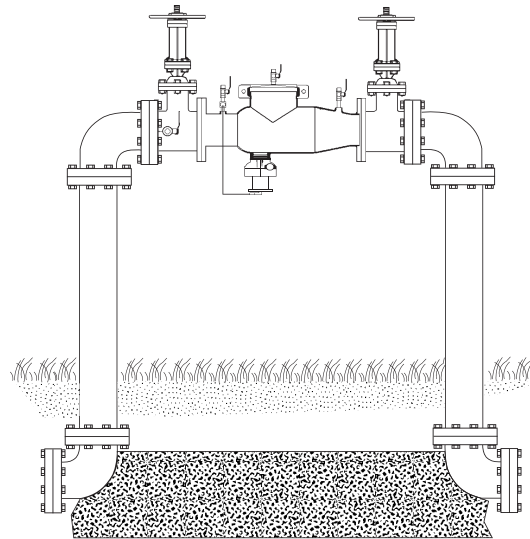

# Servicing the First and Second Checks

## ⚠ WARNING

Depressurize valve before servicing.

Before servicing, be certain the shutoff valves are closed. Then use the following procedure to remove the check assemblies.

1. Slowly open all ball valves to relieve air and water pressure. Loosen the bolts on the groove coupler and remove the groove coupling and cover plate from the valve body. (See Figure 1.)
2. Remove check assembly #1 by hand, turning the screws counterclockwise to release the check and remove it through the top access port. Do not use the check arm as a handle to unscrew the unit. If the check cannot be loosened by hand, insert a long screwdriver between the valve body and the check. (See Figure 2.) Gently apply pressure against the check until it is loosened. Finish unscrewing by hand. (See Figure 3.) Unscrew check #2 by turning counterclockwise, placing a long screwdriver across the lugs and applying pressure to loosen the check. (See Figure 4.) Finish unscrewing by hand.
3. (For 6" only) To clean check #1, locate the check arm opening stud on the outlet flange of the valve assembly. Slide the check arm over the stud with the check threads facing downward. (See Figure 5A.) Tighten the 1/4" nut on the stud to secure the cam bar. Slowly pull the assembly outward to open the check, allowing exposure of the seat clapper area for cleaning. To clean check #2, lift the cam arm and hold it in the open position. (See Figure 4.) Raise the clapper so that the end of the check arm rests between the roller and the clapper. (See Figure 5B.) Thoroughly clean the seat area and clapper sealing surfaces of both checks. Inspect seats, clapper sealing surfaces, check arms, and O-rings for damage, nicks, and debris. If not damaged, gently close the clapper. If damaged, install a new check assembly or O-ring, or both.
4. Before reinstalling the checks, thoroughly clean the O-ring groove and lubricate the O-ring with an FDA Approved lubricant. Insert and thread check #2 first and then check #1. Check #2 should be tightened by inserting a long screwdriver between the lugs to tighten firmly. (See Figure 2.) Do not over-tighten. Tighten check #1 firmly by hand only. Replace the cover plate, clean groove coupler gasket, and groove. Replace the groove coupler. Re-pressurize and bleed air from all the test cocks.

Figure 1

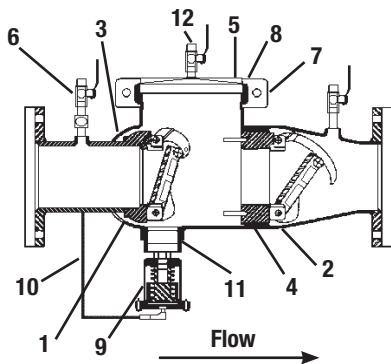

ITEM	DESCRIPTION	ITEM	DESCRIPTION
1	#1 Cam-Check	7	Groove Coupler
2	#2 Cam-Check	8	Groove Coupler Gasket
3	#1 Cam-Check O-ring	9	Relief Valve (complete assembly)
4	#2 Cam-Check O-ring	10	Relief Valve Hose
5	Cover Plate	11	Relief Valve Body O-ring
6	Ball Valve	12	Washer, Shutoff

Figure 2

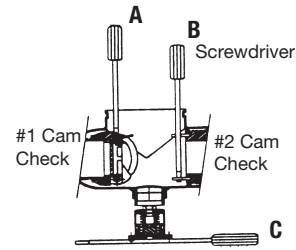

Figure 3

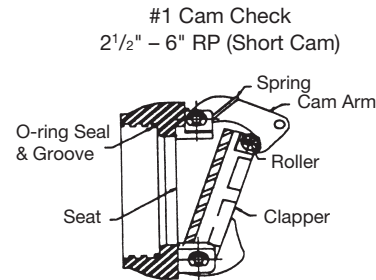

Figure 4

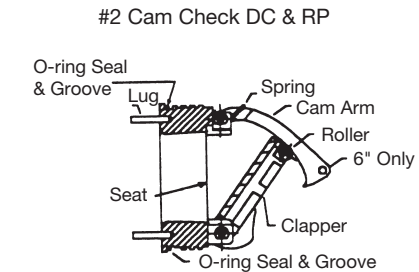

Figure 5A

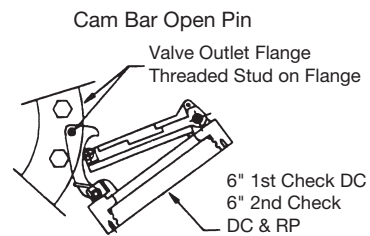

Figure 5B



# Servicing the Relief Valve

## ⚠ WARNING

Depressurize valve before servicing.

The relief valve may be serviced while on or off the backflow preventer valve. (See the components in relief valve in Figure 1.)

Figure 1

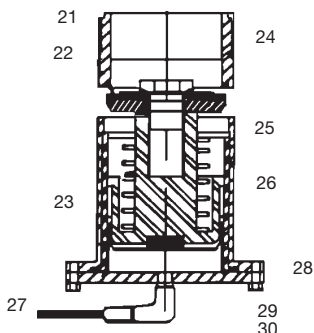

ITEM	DESCRIPTION
21	Relief Valve Body
22	Rubber Shutoff Disc
23	Piston Diaphragm Assembly
24	Hex Head Bolt
25	Disc Retainer
26	Sleeve
27	Bottom Bolt
28	Bottom Flange (w st. elbow)
29	Bottom st. elbow
30	O-ring disc

## NOTICE

Do not use a pipe wrench to remove the relief valve assembly from the backflow preventer.

### To disassemble the relief valve

1. Detach the activation module, if installed, from the flood sensor then use a #2 Phillips screwdriver to remove the sensor from the relief valve.
2. Disconnect the relief valve hose from the elbow in the bottom flange cover at the swivel hose connection. Do not remove the elbow.
3. If the valve is to be removed from the backflow preventer for service, place a screwdriver blade or flat bar across the edges of two of the hex head screws in the bottom flange cover and turn counterclockwise to loosen the relief valve assembly.
4. Remove the four bottom bolts from the bottom of the relief valve assembly with a 5/16" socket or open-end wrench. Remove the bottom flange cover.
5. Remove the piston assembly and sleeve from the relief valve body by placing the index fingers through the slots in the side of the body and pressing down on the top of the disc retainer in the top of the piston assembly. (See Figure 2.) Pull the piston assembly free of the body by grasping the sleeve and pulling down.

Figure 2

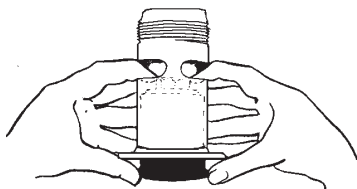

6. Grip the sleeve and the piston assembly by the head of the hex head bolt. Pull up on the sleeve to extend the diaphragm. Slide the sleeve (item 26) completely off the diaphragm and inspect the diaphragm for tears, holes, or excessive wrinkles. If the diaphragm is damaged, order a new piston-diaphragm assembly.

### To reassemble the relief valve

1. Thoroughly clean all inside surfaces of the relief valve body.
2. Inspect the relief valve body seat surface located at the top edge of the three discharge slots near the top of the body by rubbing the end of an index finger around the entire seat surface; access the seat surface through the slots or the bottom of the body. The seat must be free of nicks. If nicks are discovered, remove the body and install a new relief valve assembly.
3. Position the diaphragm on the piston assembly so that it is facing up. (See Figure 3.)

Figure 3

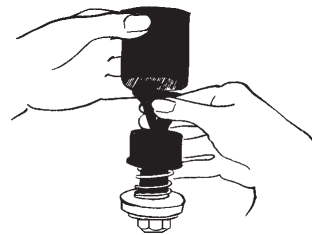

4. Fold the top (ribbed) edge of the diaphragm inward, grasp the sleeve with the ribbed edge up, and slide the sleeve down over the piston assembly.
5. While still holding the sleeve, slide it up over the diaphragm and, using your thumb and index finger, position the bead of the diaphragm so that it wraps over the outside of the rib on the top of the sleeve so that the sleeve is held by the diaphragm. Place the piston assembly on a flat, firm surface with diaphragm facing up. (See Figure 4.)

Figure 4

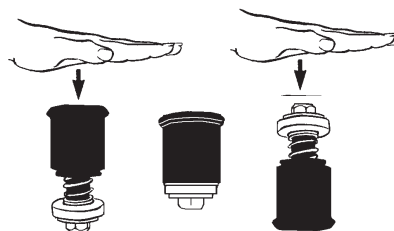

6. Cup a hand slightly to form an air trap and force the sleeve down over the piston assembly with a rapid slap (hard) on the open end of the diaphragm with the cupped hand. The trapped air in the diaphragm forces the diaphragm between the inside of the sleeve and the outside of the piston. Ensure that the diaphragm is fully seated. If diaphragm is wrinkled, repeat the previous step.
7. Slide the piston assembly and sleeve into the relief valve body with the hex head bolt entering the flanged end of the body first. Slide the piston assembly in until the diaphragm lip is smoothly seated in the machined groove in the flanged end of the body. Run an index finger around the outside of the diaphragm bead to ensure it is seated smoothly.
8. Position the bottom flange cover on the bottom of the relief valve body and secure it by hand-tightening the four bottom bolts.
9. Tighten the four bottom bolts to approximately 15 ft-lb with a 5/16" socket or open-end wrench, then reattach the relief valve hose to the elbow in the bottom flange cover. Reattach the flood sensor to the relief valve and mount the activation module to sensor.

# Testing Reduced Pressure Zone Assemblies

Follow the requirements of each test when performed to ensure successful installation, operation, and maintenance of the backflow preventer.

Ball Type Test Valves

## Test No.1

**Purpose:** To test check valve No. 2 for tightness against reverse flow.

**Requirements:** Valve must be tight against reverse flow under all pressure differentials. Slowly open the 'high' valve A and the 'vent' valve C, and keep the 'low' valve B closed. Open test No. 4. Indicated pressure differential is expected to decrease slightly. If pressure differential continues to decrease (until the vent opens) check valve No. 2 is reported as 'leaking.'

## Test No. 2

**Purpose:** To test shutoff No. 2 for tightness.

**Requirements:** After passing test No. 1, continue to test No. 2 by closing test cock No. 2. The indicated pressure differential is expected to decrease slightly. If pressure differential continues to decrease (approaching 'zero'), shutoff No. 2 is reported to be 'leaking.'

## Test No. 3

**Purpose:** To test check valve No. 1 for tightness.

**Requirements:** Valve must be tight against reverse flow under all pressure differentials. Close 'high' valve A and open test cock No. 2. Close test cock No. 4. Disconnect vent hose at test cock No. 4. Open valves B and C, bleeding to atmosphere. Then closing valve B restores the system to a normal static condition. Observe the pressure differential gauge. If there is a decrease in the indicated value, check valve No. 1 is reported as 'leaking.'

## Test No. 4

**Purpose:** To test operation of pressure differential relief valve.

**Requirements:** The pressure differential relief valve must operate to maintain the 'zone' between the two check valves at least 2 psi less than the supply pressure. Close 'vent' valve C. Open 'high' valve A. Open the 'low' valve B very slowly until the differential gauge needle starts to drop. Hold the valve at this position and observe the gauge reading when the first discharge is noted from the relief valve. Record this as the opening differential pressure of the relief valve.

### NOTICE

The differential gauge needle **MUST** drop slowly. Close test cocks No. 2 and No. 3. Use the 'vent' hose to relieve pressure from the test kit by opening valves A, B, and C. Remove all test equipment and open shutoff No. 2.

### CAUTION

To prevent freezing, hold Test Kit vertically to drain differential gauge and hoses prior to placing in case.

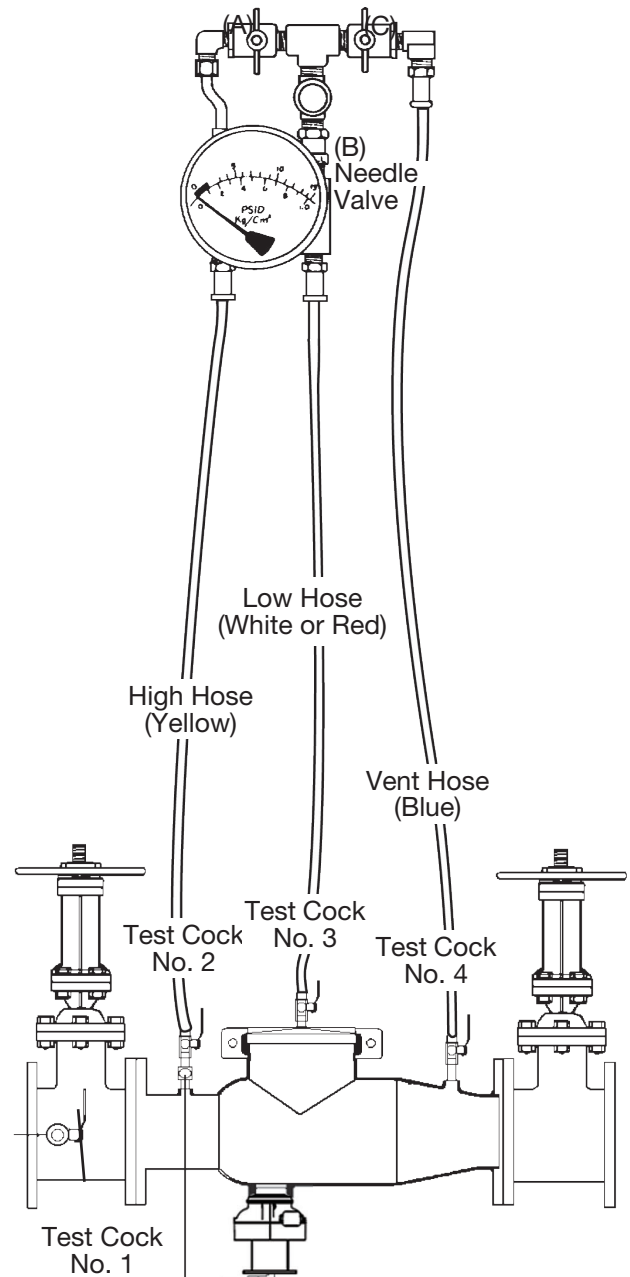

# Troubleshooting



PROBLEM	CAUSE	SOLUTION
Assembly discharges from differential relief valve during no flow condition	Fouled first check	Disassemble and clean check valve #1
	Fluctuating inlet pressure	Control supply line water pressure Install a soft-seated, spring-loaded check valve upstream of the assembly
	Outlet pressure higher than inlet pressure and leak in check valve #2	Disassemble and clean check valve #2 and identify cause of backpressure
	Leak through diaphragm or around flange bolt holes of relief valve	Service relief valve
	Pressure relief valve does not close	See problem 'Pressure relief valve does not close'
Assembly discharges from differential relief valve during a flow condition	Check valve #1 wedged open	Disassemble and clean check valve #1
	O-ring displaced from groove in check #1	Disassemble and replace
	Pressure relief valve does not close	See problem 'Pressure relief valve does not close'
	Fluctuating line pressure	Install pressure sustaining check upstream of backflow
Differential pressure relief valve does not open during test	Differential pressure across check valve #1 stays above 2.0 psi due to leaking outlet gate valve	Repair shutoff valves
	Weak or broken relief valve spring	Disassemble and replace relief valve spring
	Shutoff seat tube bound in body	Disassemble and repair
	Plugged hydraulic hose	Disassemble and repair
Pressure relief valve does not close	Debris on sealing surface	Remove relief valve and clean
	Plugged hydraulic hose	Disassemble and clean
	Damaged seat or rubber shutoff disc	Remove relief valve assembly and replace
	Ruptured diaphragm	Disassemble and replace diaphragm
	Wrinkled or improperly installed diaphragm	Disassemble and properly position diaphragm

## Problem Identification Procedures



When using differential pressure gauge	
Check differential across No. 1 check valve	
READING	PROBLEM
2 to 3 psid	Leak in No. 1 or No. 2 check valve
4 to 7 psid and steady	Malfunctioning pressure relief valve
2 to 7 psid	Inlet pressure fluctuation

Without using differential pressure gauge	
A. Close gate valve No. 2	
RESULT	PROBLEM
If discharge stops	Leak in No. 2 check valve
If discharge does not stop	Go to B
B. Open No. 4 test cock to produce a flow greater than differential relief valve discharge	
RESULT	PROBLEM
If discharge stops	Leak in No. 1 check valve
If discharge does not stop	Malfunctioning pressure relief valve

## Add-on and Retrofit Sensor Connection Kits for Building Management Systems

ORDERING CODE	ADD-ON/RETROFIT KIT	DESCRIPTION
88009418	 FP-BF-BMS-21/2-10 BMS Sensor Connection Kit Series 4000SS Series 5000SS Sizes 2½" to 6"	Includes sensor activation module with cable, ground wire, and power adapter. Use this kit to activate the flood sensor and enable flood detection capabilities on the relief valve of a new installation linked to a BMS controller (not included).
88009419	 FP-RFK-BF-BMS-CFS-21/2-10 BMS Sensor Retrofit Connection Kit Series 4000SS Series 5000SS Sizes 2½" to 6"	Includes flood sensor, sensor activation module with cable, ground wire, and power adapter. Use this kit to install the flood sensor and enable flood detection capabilities on the relief valve of an existing installation linked to a BMS controller (not included).

## Add-on and Retrofit Sensor Connection Kits for Cellular Communication

ORDERING CODE	ADD-ON/RETROFIT KIT	DESCRIPTION
88009420	 FP-BF-CFS-21/2-10 Cellular Sensor Connection Kit Series 4000SS Series 5000SS Sizes 2½" to 6"	Includes sensor activation module with cable, Cellular Gateway with mounting kit, ground wire, and power adapter. Use this kit to activate the flood sensor and enable flood detection capabilities on the relief valve of a new installation linked to a cellular network to send alerts by email message, SMS text message, or voice call.
88009421	 FP-RFK-BF-CFS-21/2-10 Cellular Sensor Retrofit Connection Kit Series 4000SS Series 5000SS Sizes 2½" to 6"	Includes flood sensor, sensor activation module with cable, Cellular Gateway with mounting kit, ground wire, and power adapter. Use this kit to install the flood sensor and enable flood detection capabilities on the relief valve of an existing installation linked to a cellular network to send alerts by email message, SMS text message, or voice call.

**Limited Warranty:** Ames Fire & Waterworks (the "Company") warrants each product to be free from defects in material and workmanship under normal usage for a period of one year from the date of original shipment. In the event of such defects within the warranty period, the Company will, at its option, replace or recondition the product without charge.

**THE WARRANTY SET FORTH HEREIN IS GIVEN EXPRESSLY AND IS THE ONLY WARRANTY GIVEN BY THE COMPANY WITH RESPECT TO THE PRODUCT. THE COMPANY MAKES NO OTHER WARRANTIES, EXPRESS OR IMPLIED. THE COMPANY HEREBY SPECIFICALLY DISCLAIMS ALL OTHER WARRANTIES, EXPRESS OR IMPLIED, INCLUDING BUT NOT LIMITED TO THE IMPLIED WARRANTIES OF MERCHANTABILITY AND FITNESS FOR A PARTICULAR PURPOSE.**

The remedy described in the first paragraph of this warranty shall constitute the sole and exclusive remedy for breach of warranty, and the Company shall not be responsible for any incidental, special or consequential damages, including without limitation, lost profits or the cost of repairing or replacing other property which is damaged if this product does not work properly, other costs resulting from labor charges, delays, vandalism, negligence, fouling caused by foreign material, damage from adverse water conditions, chemical, or any other circumstances over which the Company has no control. This warranty shall be invalidated by any abuse, misuse, misapplication, improper installation or improper maintenance or alteration of the product.

Some States do not allow limitations on how long an implied warranty lasts, and some States do not allow the exclusion or limitation of incidental or consequential damages. Therefore the above limitations may not apply to you. This Limited Warranty gives you specific legal rights, and you may have other rights that vary from State to State. You should consult applicable state laws to determine your rights. **SO FAR AS IS CONSISTENT WITH APPLICABLE STATE LAW, ANY IMPLIED WARRANTIES THAT MAY NOT BE DISCLAIMED, INCLUDING THE IMPLIED WARRANTIES OF MERCHANTABILITY AND FITNESS FOR A PARTICULAR PURPOSE, ARE LIMITED IN DURATION TO ONE YEAR FROM THE DATE OF ORIGINAL SHIPMENT.**



**A WATTS Brand**

**USA: Backflow** T: (978) 689-6066 • F: (978) 975-8350 • AmesFireWater.com  
**USA: Control Valves** T: (713) 943-0688 • F: (713) 944-9445 • AmesFireWater.com  
**Canada:** T: (888) 208-8927 • F: (905) 481-2316 • AmesFireWater.ca  
**Latin America:** T: (52) 55-4122-0138 • AmesFireWater.com